

# Instruction Manual for Surge Pulsator

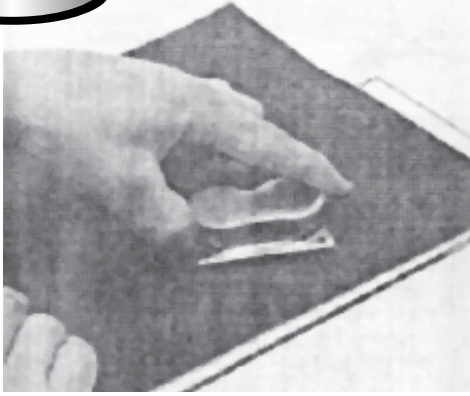

Cylinder and 180 Grit Paper with Glass: Resurface cylinders on 180 grit paper to clean base of Cylinder and to check for seal of base to gasket and block.

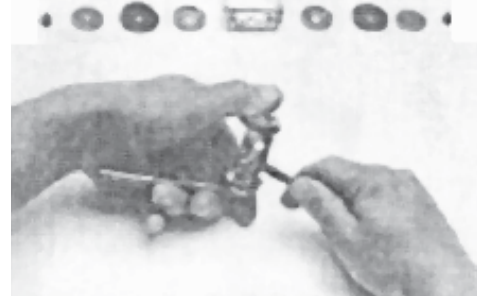

Assembly of Valve Carrier

- A. Select 4 leathers for each pulsator. Check for defects
- B. Select 4 thin flanged washers for each pulsator. Check for defects.
- C. Assemble as above, tighten washer screws.



tightening screw

'C' Style slides go into place in this order.

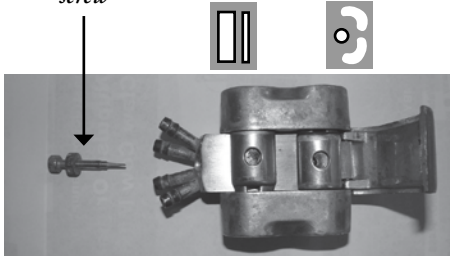

'S' Style slides go into place in this order (what you see will face down onto the main block. This is an 'x-ray' view of what should be on the bottom).



For assembly: place front and rear valves on block as pictured. ("S" pulsator uses two 10305 valves with large ports toward the adjusting screw.)

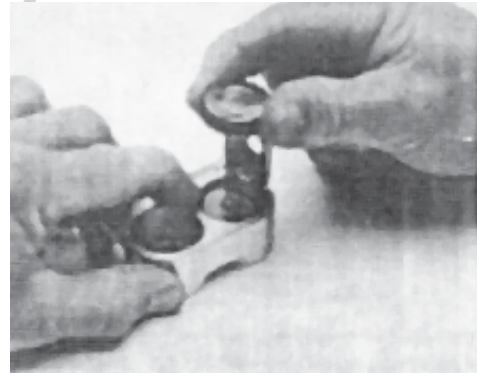

All leathers should be checked for sealing in cylinders before assembly.

Copyright 2013 Hamby Dairy Supply: You may print manual for own non-commercial use, but not for resale.

## HAMBY DAIRY SUPPLY

2402 SW Water St. Maysville, MO. 64469

1-800-306-8937 ● [www.hambydairysupply.com](http://www.hambydairysupply.com)

# Two styles of Surge lids:

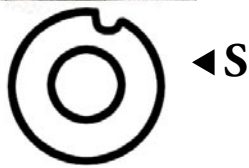

NO rubber gasket

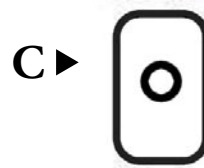
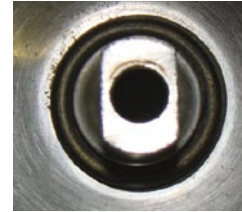

YES rubber gasket

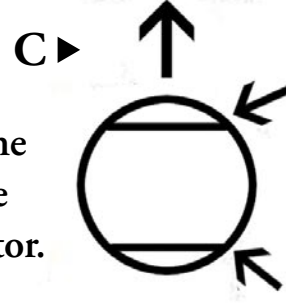
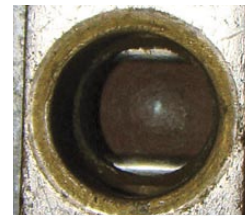
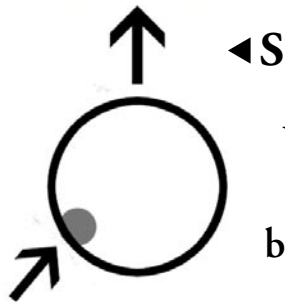

When looking at the big opening in the bottom of the pulsator.

S = smooth hole except for one knob.

C = parallel bars along front and back



## Supply

# Repair of Surge Pneumatic Pulsator No. 10300

Take the pulsator completely apart as shown. Discard all leathers, thin flanged washers and cylinder gaskets for new.

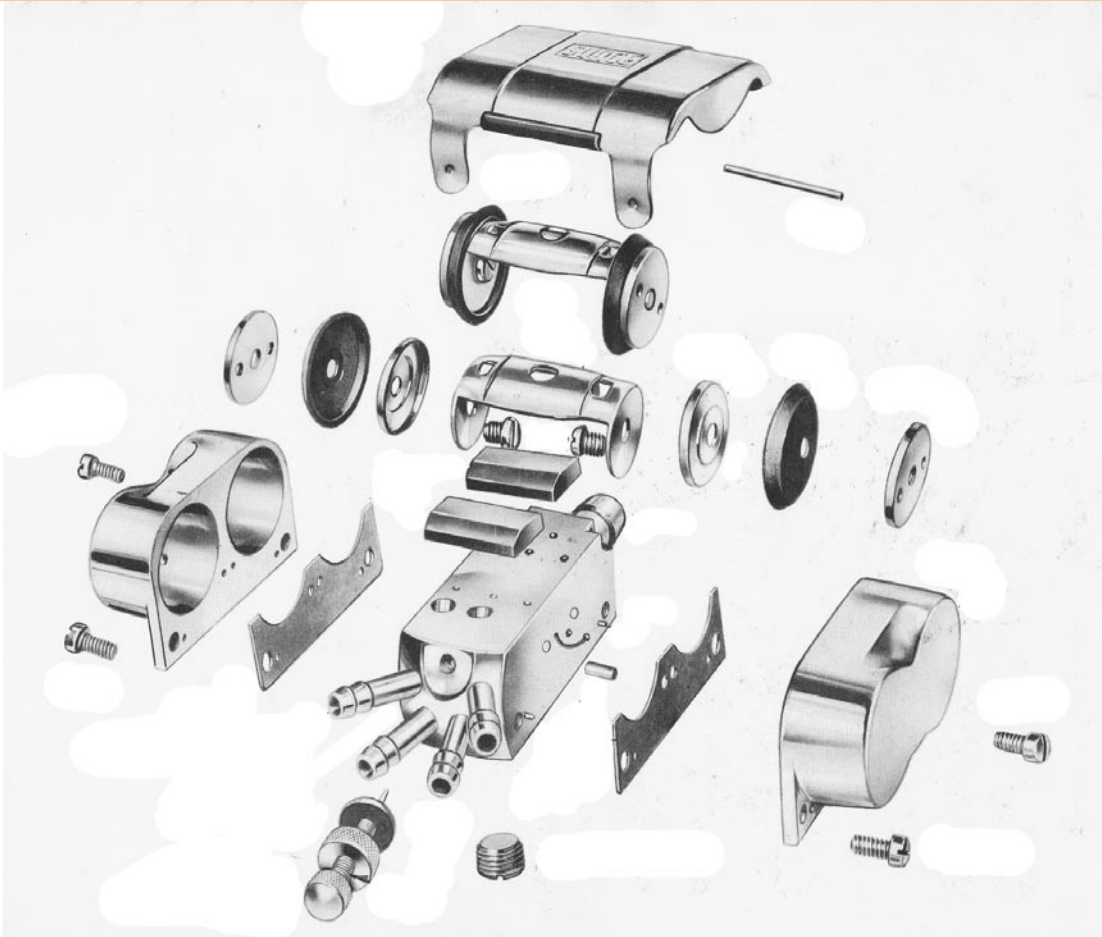

## Repair Kit: 501-103-10

### *Kit includes:*

- 2 leather strips
- 4 leather disks
- 4 tin disk 'expanders'
- 1 rubber ring
- 1 small 'O' ring (for C style only)
- rubber cap for the check valve

*Note: kit also includes pipe cleaners, which should be run through holes to clean before taking apart. You can also blow out Pulsator with an air compressor.*

Hamby Dairy



Supply

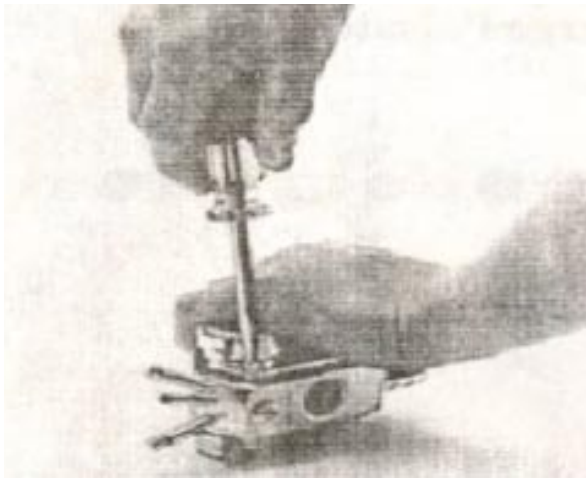

### Tightening Cylinder Screws

Make sure cylinder screws are tight. (Hold against bench to tighten screws - holding it in your hand is a frequent cause of injury when screw driver slips.) The pulsator should be put together and tested completely dry. (The leathers contain sufficient oil for 40 hours of operation.)

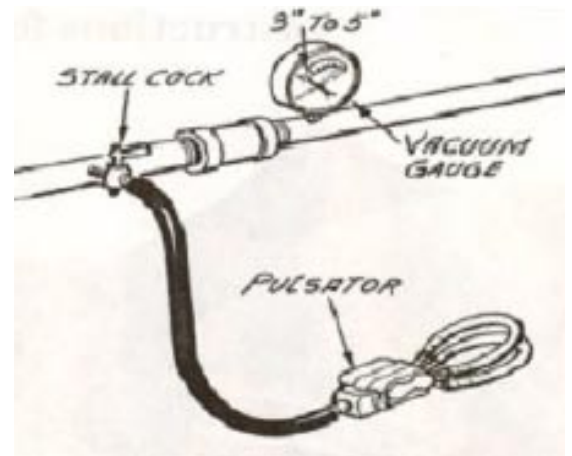

The pulsator should be adjusted to operational speed after which stall cocks should be opened to let the vacuum drop to 3" to 5". Test the pulsators with small air nipples open (less air tubes).

If the valves and valve carriers still move under the above condition, the pulsator is in an efficient operating condition.

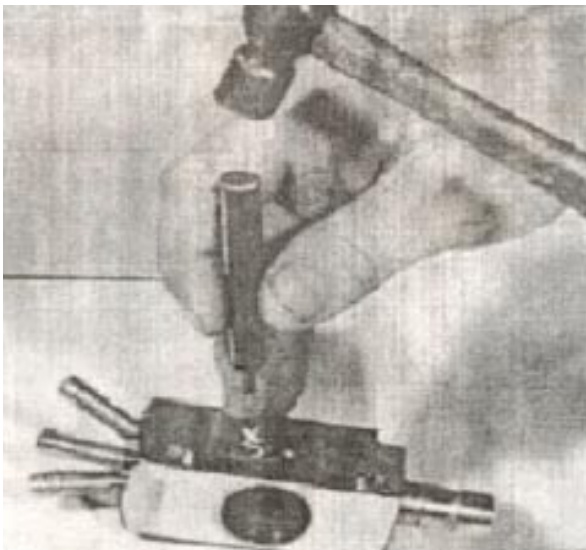

If the speed of the pulsator cannot be controlled with the adjusting screw, the regulating screw orifice is oversized. This orifice can be closed by tapping with the retaining pin punch and 4 oz. hammer. It can be reopened to the proper size by redrilling with the #55 drill.

#### Note!

The pulsator pins are delicate and block can be damaged through excessive force. Contact Hamby Dairy Supply before taking apart!



### For "S" Pulsator Only

Retaining Pin may be worn, keeping pulsator from locking on lid. When replacing, lay block across edge of table (to avoid bending or burring cylinder pins or denting side of block) and drive pin out with retaining pin punch. Be careful not to dent block when driving in new one. If pin fits loosely - tap block with punch at (X) ABOVE hole - NEVER at side or toward bottom.

NOTE - the pulsator leathers should be oiled with one drop of oil on each leather for each 40 hours of operation. Over oiling will cause the pulsator to operate inefficiently.

The valves and block require no oil. Oiling these parts will cause dust to gather at the valve and block resulting in excessive wear.

#### Note!



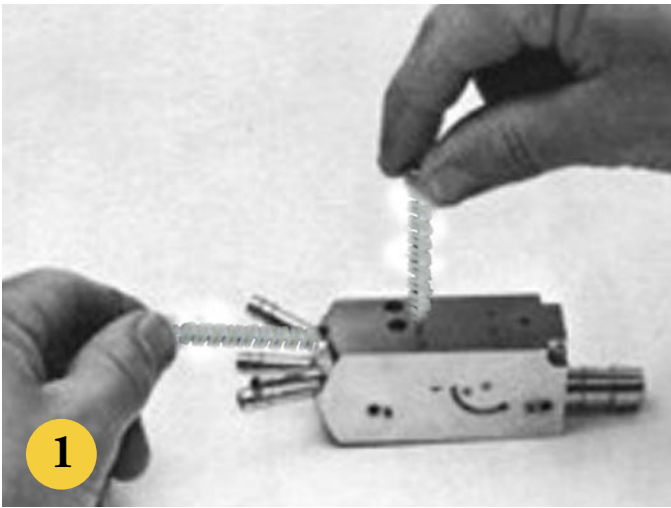

To efficiently clean the smaller port of the adjusting screw, place pipe cleaner from kit in the port as shown in photo above. Place additional pipe cleaner in the vertical converting port. Using both pipe cleaners at one time will clean the right angle ports completely.

Replace loose or bent small air nipples and gasket pins as needed. (Electrician pliers should be used to remove gasket pins.)

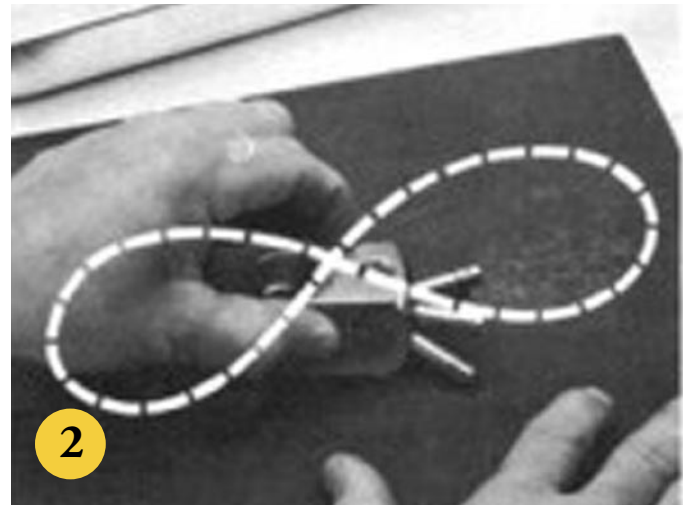

Remove speed screw and use medium grit emery cloth on a smooth surface. Resurface with an up/down motion (not side-to-side).

The block needs to be resurfaced under the valve only. Discount marks on block made by the valve carrier.

Use medium grit emery cloth to polish the block, following the same procedure as above.



Check valves by polishing on the coarse side of the medium grit emery cloth. When valves are polished, hold the valve to the light and check surface to determine if valve seat will seal. If the polished valve shows that it will leak around the edges of the ports, use medium grit emery cloth until smooth.

When installing new valves, check for any defects by following the above procedure.

# Hamby Dairy



# Supply